

zudek 



“I work to satisfy my study and research need. Research is about knowledge and curiosity. This means dealing with others, communicating, finding new directions”

Alessandro Zudek

Zudek is a constantly evolving company. Since 1990, when it started with civil, industrial and naval installations maintenance, it never stopped.

Research is its flagship.

“I work to satisfy my study and research need. Research is about knowledge and curiosity. This means dealing with others, communicating, finding new directions”, says Alessandro Zudek.

Zudek added, each and every year, a new element to its growth, designing and creating increasingly advanced products.

Today they are present in the worldwide market with highly innovative and ecological products, at very low energy costs and with low environmental impact.

They use heat emissions and create cold chains. Zudek’s challenge always was making chill in the most efficient and ecological way.

Ammonia is used, a naturally occurring gas, that doesn’t pollute. Completely different from all other gases, chemically made, with high energy costs.

Zudek designs and manufactures customized solutions, fitting with customer needs. When a company decides to follow Zudek philosophy for its plants, tools and maintenance, actually grows. Usually, this kind of companies grows quickly. In fact, a customized solution is not just a dream, it is a need. It provides several benefits that standard solutions are not able to give. Zudek is a responsible company, caring for environmental balance, ready to spread this ecological approach to new generations. Zudek is carrying out, with success, this growing process, as they believe that a growing company is a pioneer. These last years were, for Zudek, rich of news. High technology and power saving products, a new brand to tell the world their dreams, values and experience.

Thanks to a teamwork that involved each and every one: engineers, technicians, workers, collaborators, as well as suppliers and customers.

Our history

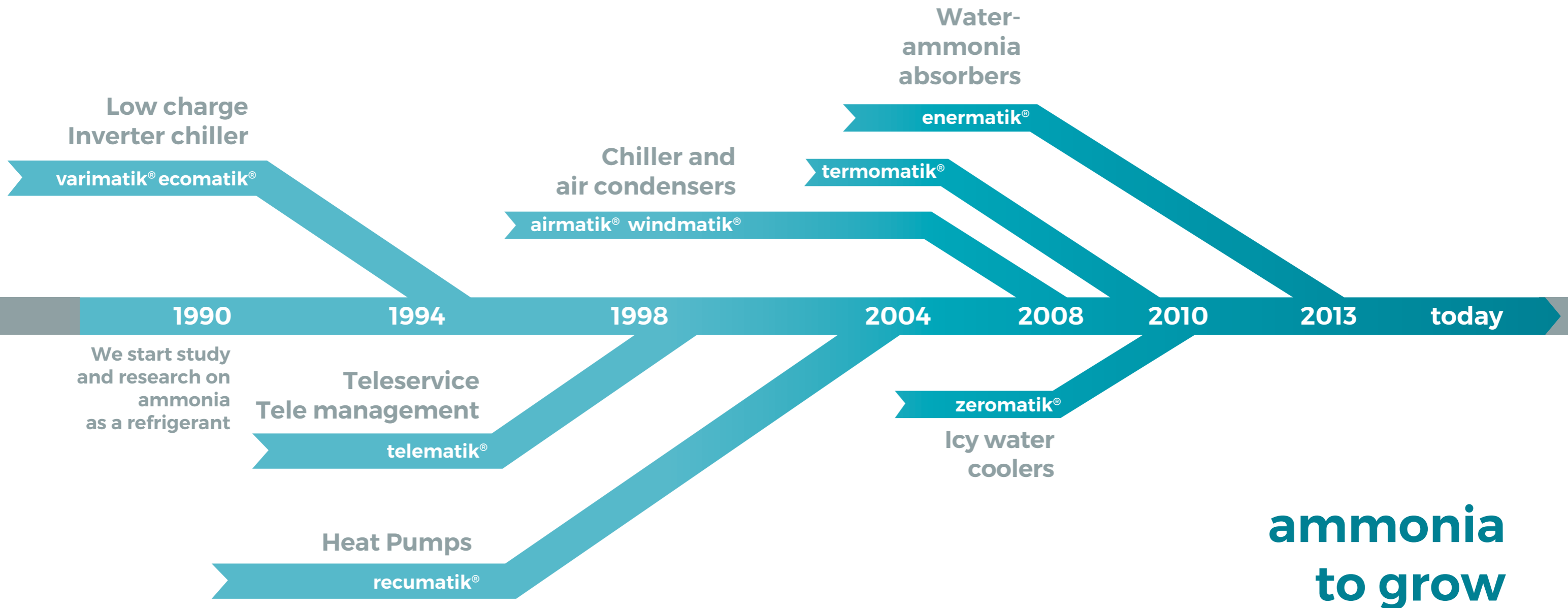

8 reasons to choose Zudek

We are producing Ammonia Chillers for over 25 years

1 Ecological

Natural and ecological ammonia ensures the highest installations efficiency. Zudek offers his consolidated experience in refrigeration field, makes use of ammonia at the highest levels of efficiency and safety today available.

2 Sustainable

Being a **green-chiller** means reducing power costs and CO₂ emissions

3 Strong

Self-supporting structure in steel carbon, galvanized and painted or in stainless steel.

Easily transportable, it is designed to last even in extreme conditions and to facilitate maintenance.

4 Efficient

Maximum efficiency today achievable on the market, thanks to the refrigerant and to the technologies used.

5 Compact

Ammonia physical properties allow to reach the highest values of efficiency (COP) today achievable by chilling systems, so allowing to reduce the installation size and to increase its durability.

6 Tested

Certified power performances. **Power Test** is a warranty for customers.

7 Trackable

telematik[®] allows to perform working machine analysis and regulation on-line.

8 Customizable

We can change any elements according to customer needs and requests. All chillers are designed and built in ATEX version.

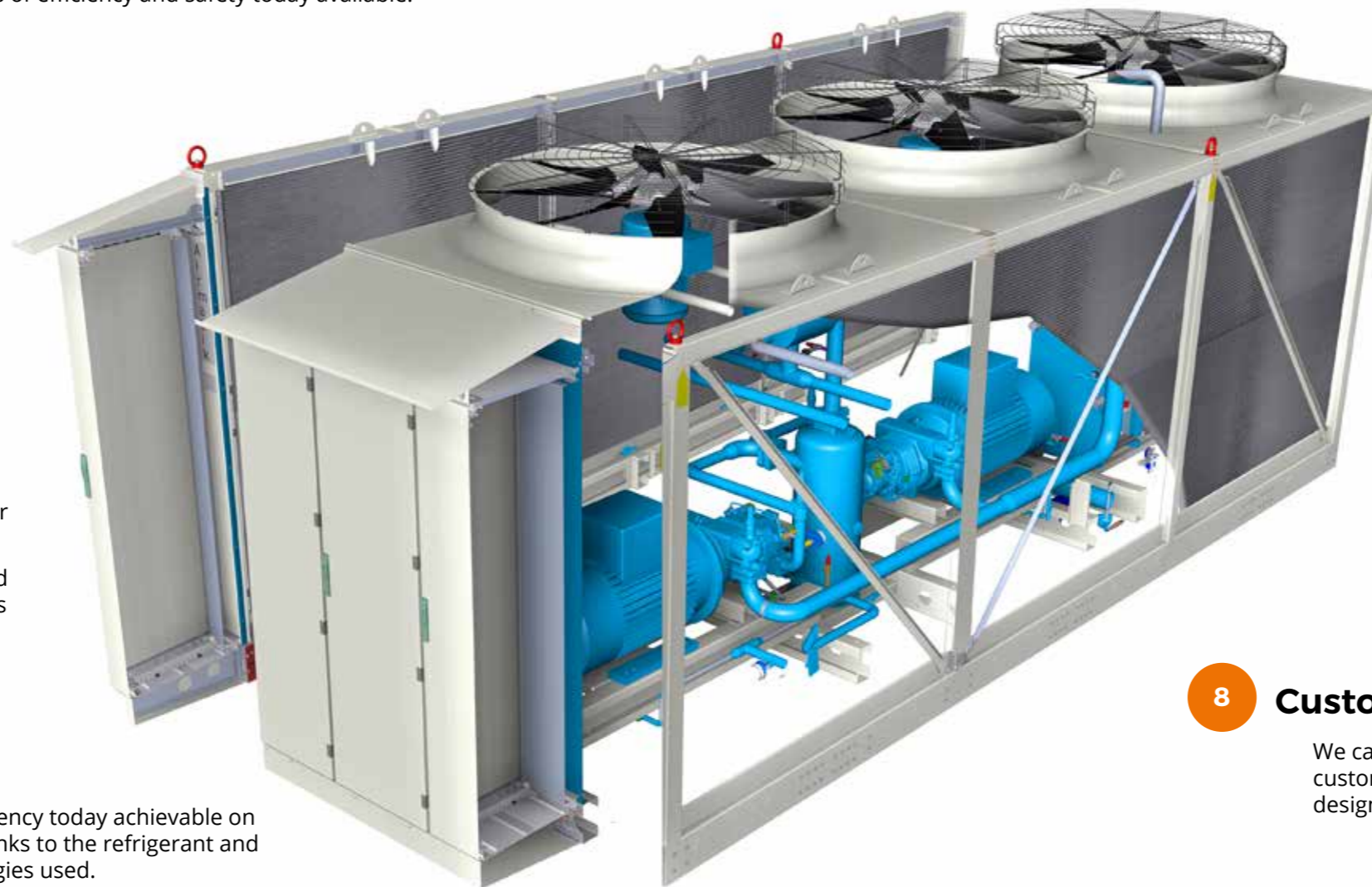

Solutions

Customer Request	water +90°C/+60°C	water +20°C/+10°C	water +12°C/+5°C	water +5°C/+0,5°C	glycol -5°C/-15°C	glycol -20°C/-30°C	NH ₃ Pumped -35°C/-40°C
Application Range	Heating	Plastic Industry Thermal Treatments	Conditioned Air	Dairies Wineries Dehumidification Icy water	Supermarkets Cold Stores Meat Processing Thermal Processing	Chemistry Pharmaceutical Thermal Processing Cold Stores	Freezing Deep freezing Cold Stores
Zudek possible solutions	recumatik® Heat pumps Single and two-stage	airmatik® up to 1200 kW up to 38° C (external)	airmatik® up to 1000 kW up to 38° C (external)	airmatik® + zeromatik® up to 900 kW up to 38° C (external)	airmatik® up to 900 kW fino a 38° C esterni	airmatik® up to 760 kW up to 38° C (external)	airmatik® fino a 680 kW up to 38° C (external)
		varimatik® up to 3000 kW	varimatik® up to 2500 kW	varimatik® + zeromatik® up to 2000 kW	varimatik® up to 1800 kW	varimatik® up to 900 kW	varimatik® up to 800 kW
		ecomatik® up to 4500 kW	ecomatik® up to 4500 kW	ecomatik® + zeromatik® up to 4000 kW	ecomatik® up to 3000 kW	ecomatik® up to 1500 kW	ecomatik® up to 1500 kW
				enermatik® + zeromatik® up to 700 kW	enermatik® up to 500 kW	enermatik® up to 400 kW	enermatik® up to 300 kW
Benefits	Geothermal exploitation or sub-zero pairing	Hybrid Chiller with wintry adiabatic operation	Best COP in every exercise condition	Icy water at 0° with no need of ice accumulation	Best alternative to indoor cooling stations	Super compact Chiller with open integrated economizer	The chiller replacing central cooling system

Product Line



Air condensed

airmatik®
termomatik®
windmatik®

page 12

page 14

page 15

page 18



Water condensed

varimatik®
ecomatik®

page 22

page 24

page 28



Absorbers

enermatik®

page 32

page 34



Heat pumps

recumatik®

page 40

page 42



Icy water Chiller

zeromatik®

page 46

page 46



Accessories and components

page 48

Services



Design

page 58



Installations Manufacturing

page 60



Power Test

page 62



Teleservice telematik®

page 40

page 42



Reviews

page 66



Software and Cybernetics

page 68



Some years ago, Carrefour opened a new structure near Paris. It was a big supermarket with at least 40 cash registers. They decided to use, for this new store, the best cold technologies for food preservation.

After an accurate research on the industrial refrigeration market all over Europe, they chose Zudek.

Why? Because we use ammonia and we are ecologically compatible with their needs. Because our machines use little electric power and are highly performing.

Because our machines maintenance is easy and remote-manageable. But, primarily, because we built a “customised” solution for their specific needs.

- 1 Micro channels condensers**
The best technology with aluminium micro channels today available, to ensure the highest thermal exchange and the lowest ammonia charge. Every condenser is individually selectable.
- 2 1600 mm diameter fans**
The large fans diameter ensures a very low consumption for ventilation and a high noise reduction
- 3 Low Sound Emission**
Axial fans with aerofoil blades ensure a net cut in sound emissions

Product line

airmatik® 6 12500 kg

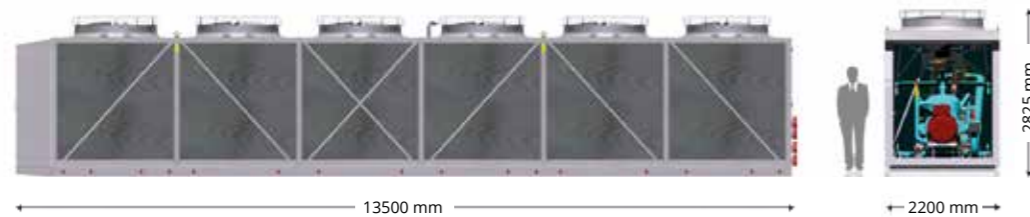

airmatik® 5 10000 kg

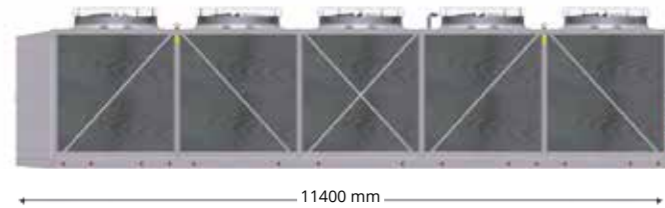

airmatik® 4 8500 kg

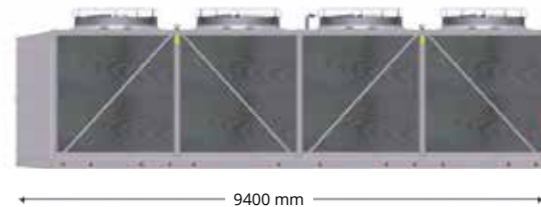

airmatik® 3 7000 kg

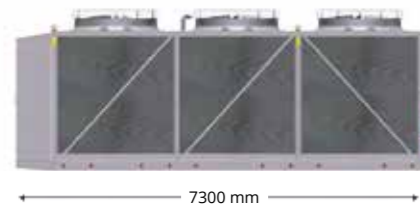

airmatik® 2 6000 kg

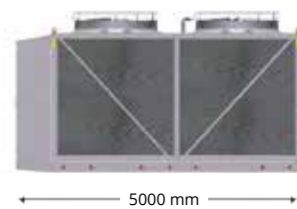

Characteristics

- Powers up to 1200 kW
- All electric engines are driven by inverters
- The chiller is totally PLC controlled with an adaptive working logic
- Very low refrigerant charge
- Power efficiency is higher than in all chillers using synthetic refrigerants
- PED 97/23/CE certification and test according to ISO 9001:2008
- Axial fans with large diameter air foil blades with very high efficiency
- 2,75 kW electric power of ventilation for every 100kW thermal power of condensation
- cold parts insulation
- **termomatik®** oil cooling system with natural circulation of ammonia

Options and accessories

- Engines and inverters available with IE4 efficiency
- Stainless steel or titanium evaporators with flooding or dry expansion power
- Evaporators or separators for pump installations
- Continuous management, supervision and teleservice with **telematik®**
- Cooling and electrical energy metering system with "certified" COP
- Partial or total heat recovery
- Available with pumping units mounted on board
- Adiabatic condensation variant for high external temperatures
- Available with hail grids
- Anticorrosive treatment condenser coils
- Anticorrosive versions totally in stainless steel
- Super silenced versions
- ATEX versions



We have 40 airmatik® working in different countries, all over the world, since 2009

Technical data

Screw compressor

Environment air temperature 35°C

	water +7°C/+12°C					water/glycol -10°C/-5°C				
	air2	air3	air4	air5	air6	air2	air3	air4	air5	air6
Cooling power	300 kW	440 kW	640 kW	800 kW	1000 kW	290 kW	430 kW	590 kW	750 kW	900 kW
EER	3,82	3,76	4.14	4.11	4.08	2.86	2.77	2.85	2.88	2.81

	water/glycol -20°C/-25°C					pumped ammonia -35°C				
	air2	air3	air4	air5	air6	air2	air3	air4	air5	air6
Cooling power	250 kW	360 kW	505 kW	650 kW	760 kW	225 kW	345 kW	445 kW	560 kW	680 kW
EER	1.63	1.58	1.70	1.70	1.68	1.20	1.26	1.21	1.18	1.23

Piston compressor

Environment air temperature 35°C

	water +7°C/+12°C					water/glycol -10°C/-5°C				
	air2	air3	air4	air5	air6	air2	air3	air4	air5	air6
Cooling power	315 kW	480 kW	630 kW	830 kW	990 kW	295 kW	450 kW	590 kW	700 kW	910 kW
EER	4.07	4.05	4.17	4.15	4.20	2.86	2.77	2.85	2.88	2.81

Air condenser

windmatik®

Product line

windmatik® 4 2400 kg

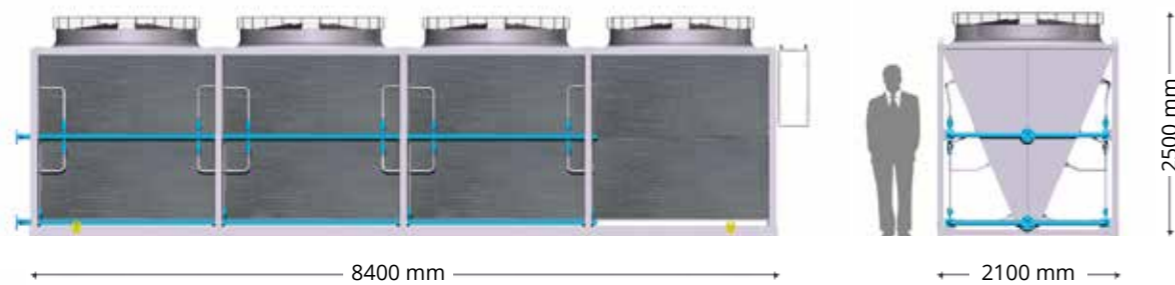

windmatik® 3 1800 kg

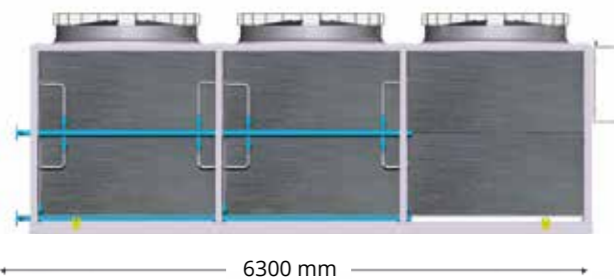

windmatik® 2 1200 kg

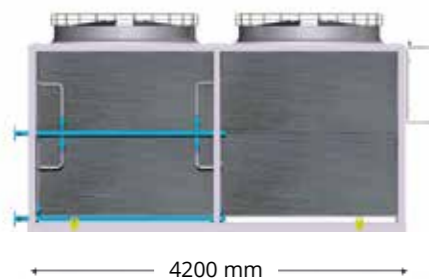

windmatik® 1 600 kg



Air condenser born from **airmatik®** experience on micro channels and super-efficient ventilation.

Characteristics:

- 1600mm diameter axial fans with a **very low electric power consumption**
- 2,75 kW electric power of ventilation for every 100kW thermal power of condensation
- independent modules to facilitate working and maintenance
- modularity allows easy expansion
- Transport and installation easiness (**available in mounting kit**)
- Every condensing coil can be individually sectioned
- Condensation pressure control through inverters
- Last generation **aluminium micro channels**
- **Very high thermal exchange** coefficient
- Can be used with all refrigerants and other exchange fluids
- PED 97/23/CE certification and test according to ISO 9001:2008

Options and accessories:

- Engines and inverters available with IE4 efficiency
- Available with liquid receiver to isolate all the refrigerant charge
- On demand with anticorrosive treatment
- Available with anti-shock and anti-hail protection
- Anti corrosion versions completely made in stainless steel
- Available with pre-wired electrical panels, inverters and safety accessories
- Control and remote maintenance through **telematik®** system
- ATEX versions

Combined system

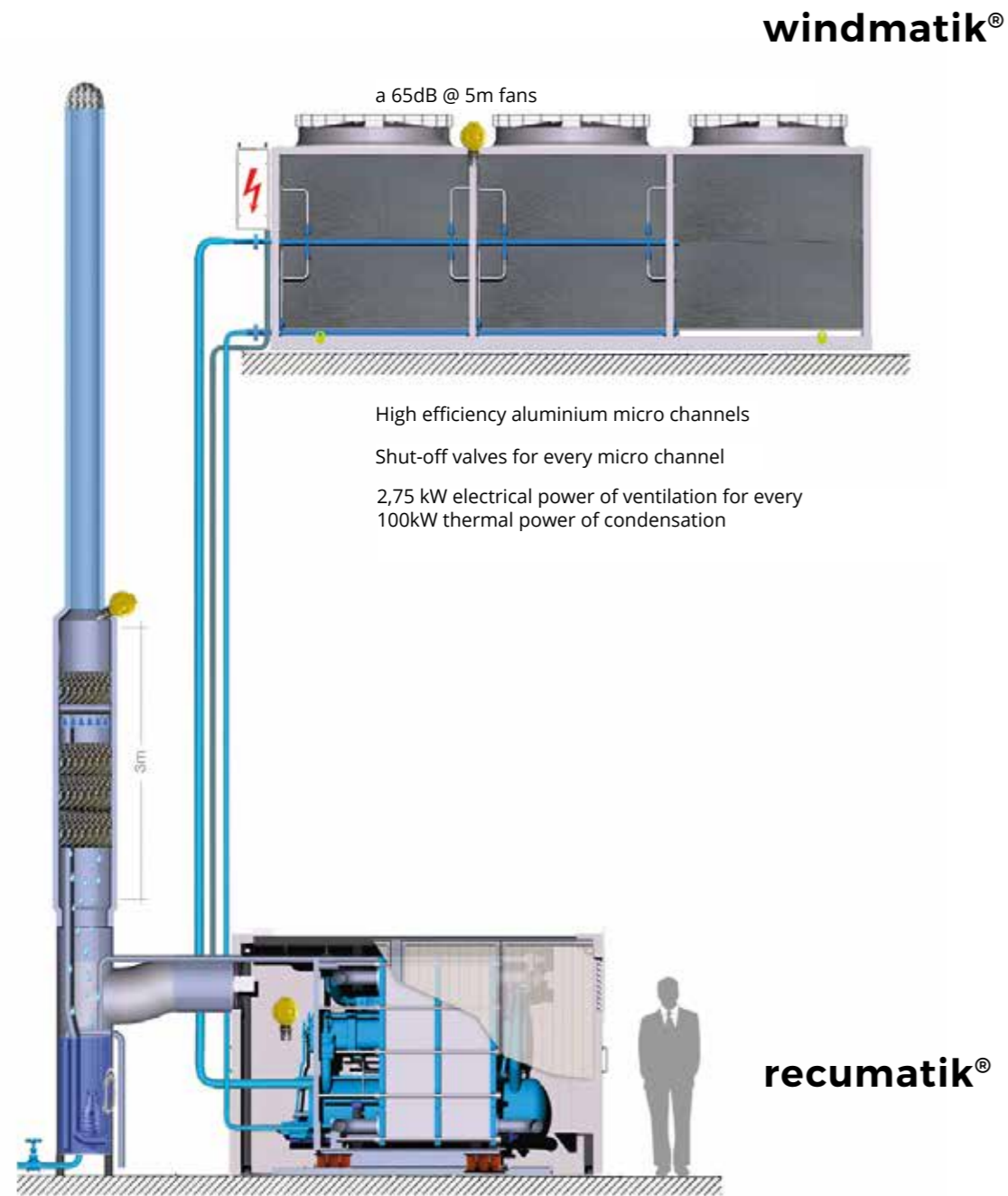

Technical data

	EXTERNAL TEMPERATURES		NH ₃ CONDENSATION TEMPERATURES			
		36°C	38°C	40°C	42°C	44°C
windmatik® 4	38°C	N.A.	N.A.	N.A.	296kW	514kW
	36°C	N.A.	N.A.	296kW	518kW	710kW
	34°C	N.A.	299kW	522kW	715kW	900kW
	32°C	301kW	526kW	722kW	917kW	1.110kW
	30°C	530kW	726kW	923kW	1.118kW	1.314kW
	28°C	731kW	928kW	1.126kW	1.323kW	1.520kW
windmatik® 3	38°C	N.A.	N.A.	N.A.	222kW	385kW
	36°C	N.A.	N.A.	222kW	389kW	533kW
	34°C	N.A.	224kW	391kW	536kW	682kW
	32°C	226kW	395kW	541kW	688kW	833kW
	30°C	397kW	545kW	692kW	839kW	985kW
	28°C	548kW	696kW	845kW	992kW	1.140kW
windmatik® 2	38°C	N.A.	N.A.	N.A.	148kW	257kW
	36°C	N.A.	N.A.	148kW	259kW	355kW
	34°C	N.A.	150kW	261kW	358kW	454kW
	32°C	150kW	263kW	361kW	458kW	555kW
	30°C	265kW	363kW	462kW	559kW	657kW
	28°C	366kW	464kW	563kW	662kW	760kW
windmatik® 1	38°C	N.A.	N.A.	N.A.	74kW	128kW
	36°C	N.A.	N.A.	74kW	130kW	178kW
	34°C	N.A.	75kW	130kW	179kW	227kW
	32°C	75kW	132kW	180kW	229kW	278kW
	30°C	132kW	183kW	231kW	280kW	328kW
	28°C	183kW	232kW	282kW	331kW	380kW

varimatik®

Mono-compressor water condensed chiller up to 3000kW

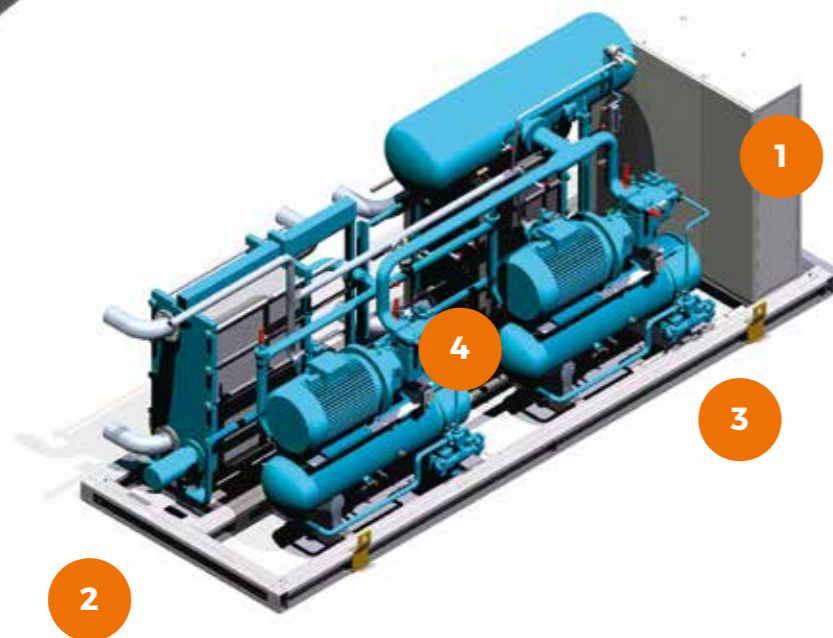
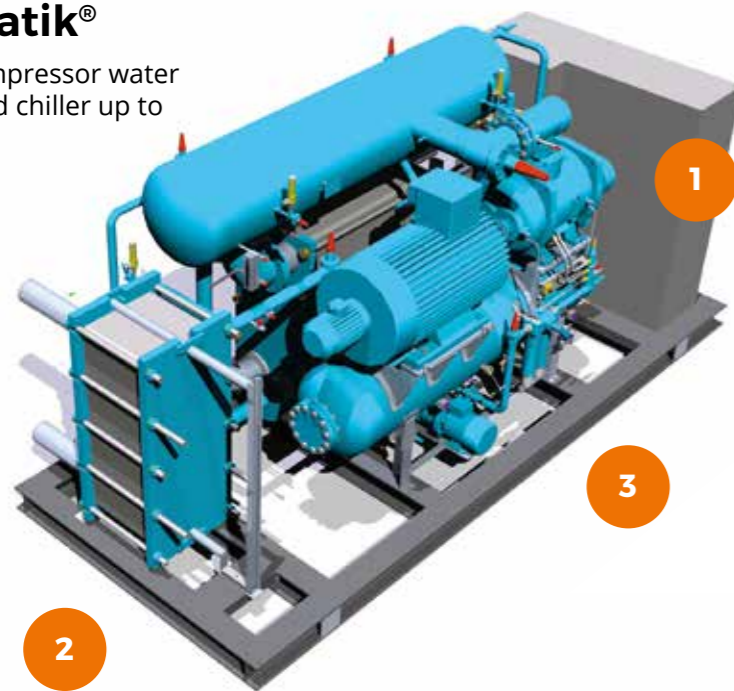

ecomatik®

Bi-compressor water condensed chiller up to 2800kW

Developed in 1994 for a customer, Illycaffè, that was tired of unreliable and poor chillers. Zudek, at those times, was engaged in maintenance. The challenge was to create a chiller, able to solve every reliability, cost management and sustainability problem.

Thanks to the inverter, flooded evaporator and PLC integrated management, **varimatik®** is constantly evaluating and adapting to all load requests.

Today we have more than 120 chillers of this kind installed in different countries.

1 Compact size

In relation to the supplied power, chiller size is studied in order to supply the most compact and easily maintainable machine; every machine includes electric drive and framework.

2 Easily transportable

varimatik® chillers are built to be easily lifted and transported with common means, in Monobloc, ready for "plug-and-play"

3 Power saving

Being a **green-chiller** means reducing costs and CO₂ emissions

4 Double compressor [**ecomatik®**]

The double compressor ensures stability and safety. It allows to increase chilling power and to optimize performance even at partial load.

Product line

varimatik® dry expansion

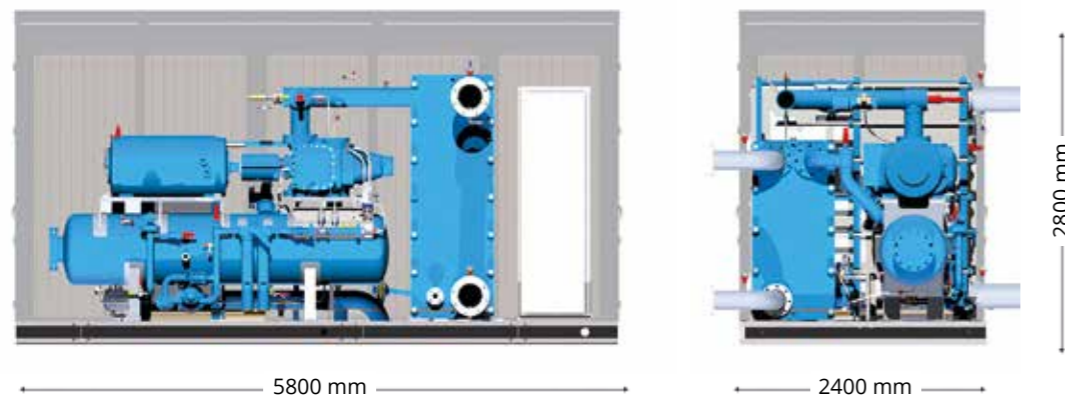

varimatik® flooded

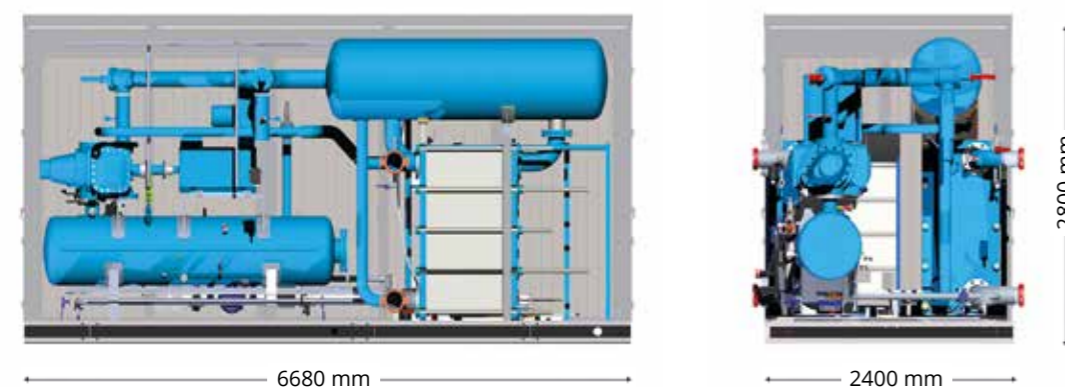

varimatik® flooded and economized for low temperatures

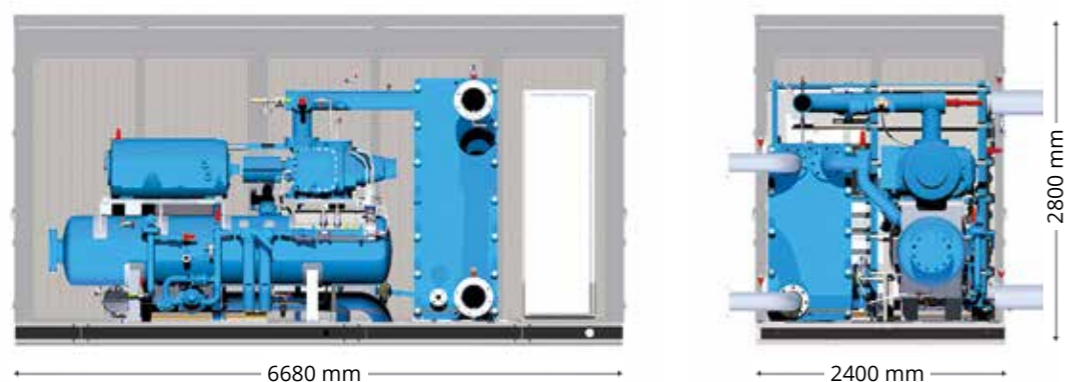

Characteristics:

- Powers up to 3000 kW
- Temperatures up to -45°C
- All electric engines are driven by inverters
- Automatic oil recovery from evaporator
- Small size in relation with the supplied power
- Semi/completed welded plates exchangers
- PED 97/23/CE certification and test according to ISO 9001:2008

Options and accessories:

- Engines and inverters available with IE4 efficiency
- Dry expansion version, further refrigerant charge reduction
- Evaporators in stainless steel or titanium with flooding or dry expansion power
- Evaporators or separators for pump installations
- Cooling and electrical energy metering system with "certified" COP's
- Partial or total heat recovery
- Available monitoring and telemetry system for the web-based management **telematik®**
- Screw or piston compressors (partial and/or total heat recovery)
- Soundproofing cabin with integrated safety devices
- Pumping unit on the machine board
- Remote type electrical panel
- Available with evaporative condenser
- Integrated separator with open economizer
- Accounting cooling and electric power system
- PED 97/23/CE certification and test according to ISO 9001:2008
- ATEX versions

Water chiller

varimatik®



We have more than 120 varimatik® working since 1994

Technical data

Screw compressor

Condensation water
30/35°C

	water +7°C/+12°C					water/glycol -4°C/-8°C				
Chilling power	600 kW	1000 kW	1500 kW	2000 kW	2500 kW	400 kW	800 kW	1200 kW	1500 kW	1800 kW
EER	6.62	6.86	6.70	6.69	6.73	4.11	4.07	4.14	4.12	4.01
	water/glycol -20°C/-25°C					pumped ammonia -35°C				
Chilling power	200 kW	300 kW	450 kW	600 kW	900 kW	200 kW	300 kW	450 kW	550 kW	800 kW
EER	2.32	2.29	2.30	2.44	2.45	1.81	1.77	1.79	1.88	1.89

Piston compressor

Condensation water
30/35°C

	water +7°C/+12°C					water/glycol -4°C/-8°C				
Chilling power	500 kW	750 kW	1000 kW	1250 kW	1500 kW	150 kW	300 kW	450 kW	600 kW	800 kW
EER	6.60	6.67	6.71	6.64	6.55	3.52	3.84	3.87	3.88	3.87

Product line

ecomatik®, thanks to the double compressor, it's suitable for applications with very variable loads, while keeping a high level of efficiency in every condition

ecomatik® dry expansion

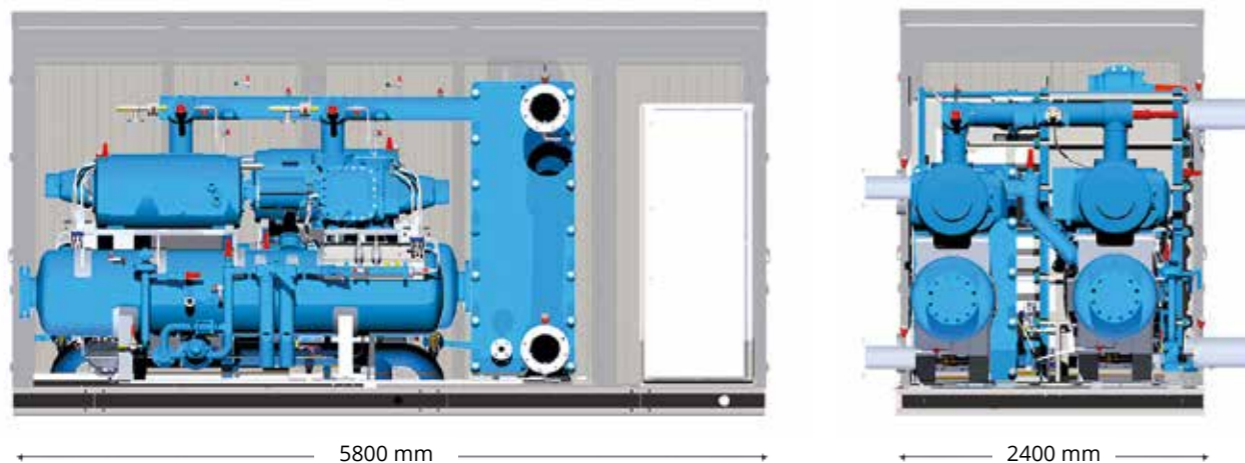

ecomatik® flooded

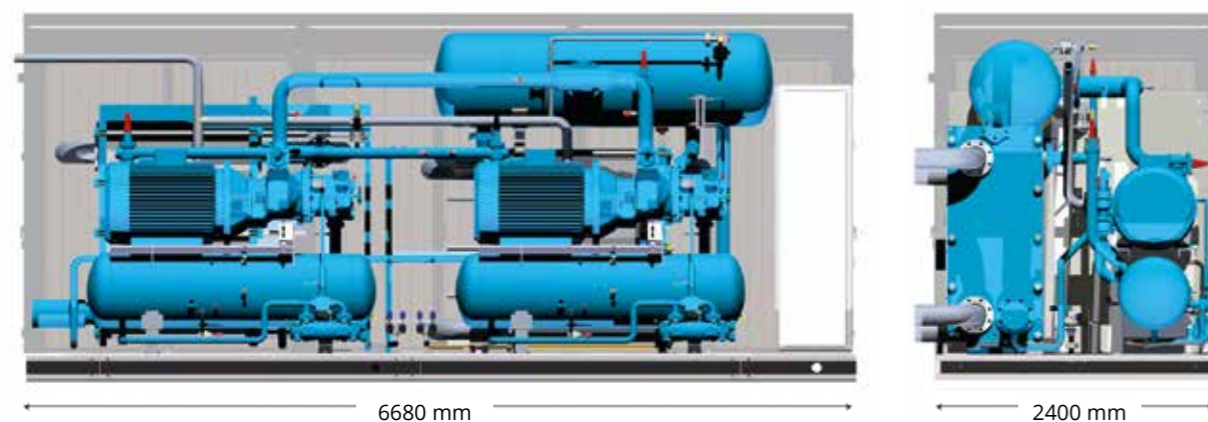

Characteristics:

- Powers up to 4500 kW
- Temperatures up to -45°C
- Electric engines with high efficiency up to IE4
- Double compressor
- Automatic oil recovery
- Small size in relation with the supplied power
- Plates exchangers
- Cold parts insulation
- PED 97/23/CE Certification and test according to ISO 9001:2008

Options and accessories:

- Dry expansion version, further refrigerant charge reduction
- Inverter installation possibility on all electric engines
- Stainless steel or titanium plates flooded evaporator
- Available supervision and telemetry system for on-the-web management **telematik®**
- Screw or piston compressors (partial and/or total heat recovery)
- New soundproofing cabin with integrated safety devices
- Pumping unit on the machine board
- Remote type electrical panel
- Available with evaporative condenser
- Integrated separator with economizer
- Accounting cooling and power system

Water chiller

ecomatik®



We have more than
60 ecomatik®
working
since 1994

Technical data

Screw compressor

Condensation water
30/35°C

	water +7°C/+12°C					water/glycol -4°C/-8°C				
Chilling power	500 kW	1500 kW	2500 kW	3000 kW	4500 kW	400 kW	1000 kW	1500 kW	2500 kW	3000 kW
EER	6.62	6.86	6.70	6.69	6.73	4.11	4.07	4.14	4.12	4.01
	water/glycol -20°C/-25°C					pumped ammonia -35°C				
Chilling power	200 kW	500 kW	800 kW	1000 kW	1500 kW	200 kW	500 kW	800 kW	1000 kW	1500 kW
EER	2.32	2.29	2.30	2.44	2.45	1.81	1.77	1.79	1.88	1.89

Piston compressor

Condensation water
30/35°C

	water +7°C/+12°C					water/glycol -4°C/-8°C				
Chilling power	500 kW	800 kW	1500 kW	2000 kW	2500 kW	100 kW	400 kW	800 kW	1000 kW	1500 kW
EER	6.60	6.67	6.71	6.64	6.55	3.52	3.84	3.87	3.88	3.87

Zudek water and ammonia absorbers reach chilled liquid temperatures which are lower than those with lithium bromide are.
Temperature range goes from **+5°C to -60°C**, to fulfil every refrigeration need.

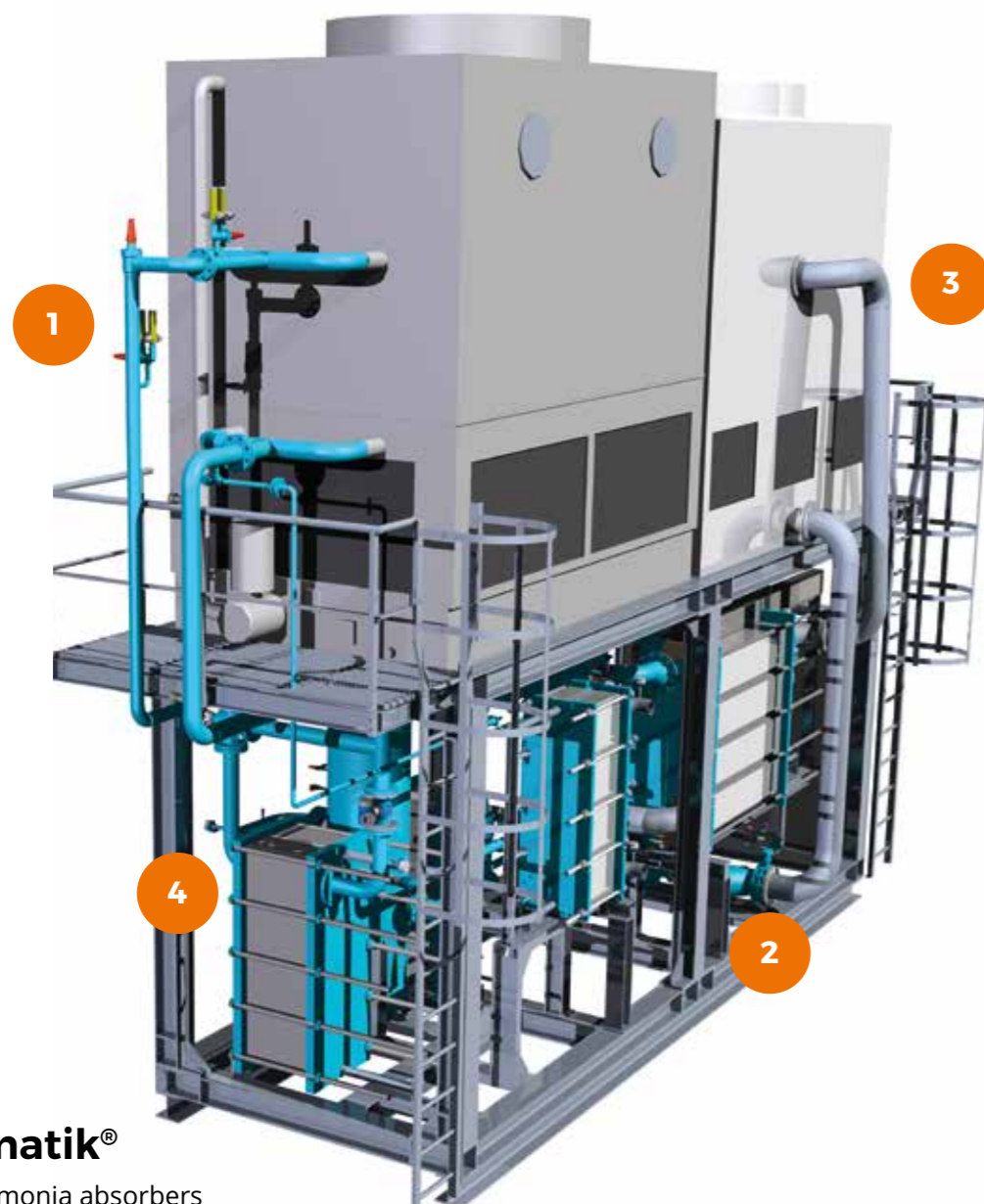

enermatik®
water/ammonia absorbers
from 0°C to -60°C

Ammonia absorption cycle in water was invented in the mid of 19th century, the actual industrial revolution in refrigeration. Zudek is studying ammonia absorbers for years. When we entered the market, we found there were just kinds of ammonia machines: the very big ones in big factories and the very small ones for camper refrigerators. To study this issue in detail, we put together a team made by our engineers and we built a prototype that could exploit the chimney flue heat.

Illycaffè roasting can generate heat up to 400 degrees.

Once, this heat used to be dispersed in the air.

We built a system that was able to catch this warm energy and transform it into 95 degrees' water. This water feeds our ammonia absorber.

The project worked very well, heat at 95 degrees feeds the absorber, that generates cold power at less than 5/6 degrees.

1 Cold without electric power

They use heat sources of every kind to generate chilling power.
They use waste industrial gases, warm process fluids, waste gases from co-generators (turbines, engines)

2 Built to last

Heat exchangers and rectification columns of the last technology, built with very high level materials. Designed to last even in extreme conditions for many decades.

3 Low maintenance

Being an 'oil-free' system with a single pump, maintenances are reduced, furtherly decreasing the installation maintenance costs.

4 Power saving

Uses together with a co-generator, it ensures a very high global efficiency, usually more than 80%, in some circumstances up to 90%

Product line

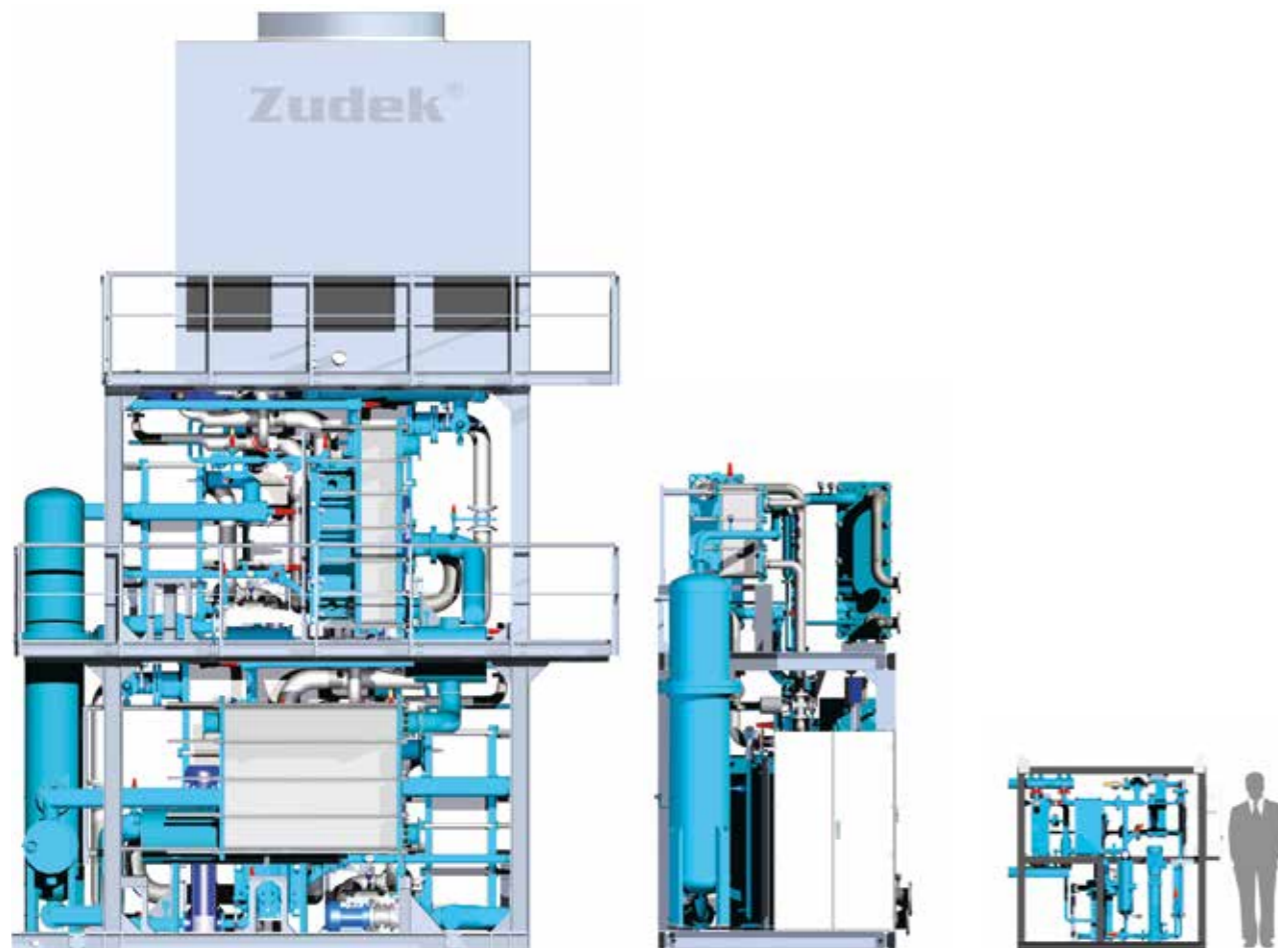

enermatik® LT
Low temperatures -35°C

Chilling power:
from 100 to 400 kW

enermatik® MT
Medium temperatures -10°C

enermatik® MLT
Medium-low temperatures -25°

Chilling power:
from 100 to 600 kW

enermatik® HT
High temperatures 0°C

Chilling power:
from 100 to 1000 kW

enermatik® absorbers for high powers and temperatures lower than -40°C are designed and supplied as an installation.

Characteristics:

- Designed and manufactured for heat waste products
- Silent and with a long life cycle (oil free) 68dbA at 1,5m in free field
- Outdoors covered mounting
- Prewired and tested electrical panel, power components, control and command, minimum IP55
- With small size in plan, the chiller is developed in height with pre-tested modules
- Advanced software provided by us and industrial hardware
- Easy to install and transport: transport, installation, fluid charge and start-up in 3 days
- Coupled with a co-generator in C.A.R. with performances higher than 80%
- All temperature and power values can be certified MID

Options and accessories:

- Stainless steel or galvanized/painted carbon steel structure
- Steel roofing and structures
- Supervision and telemetry system for web management **telematik®**
- Heat dissipation system: evaporative-condenser tower air evaporative-condenser
- Integrated pumping unit heat dissipation systemi
- Systems and tools for energy metering
- with evaporative tower or with condensers integrated in the structure

Absorption cycle

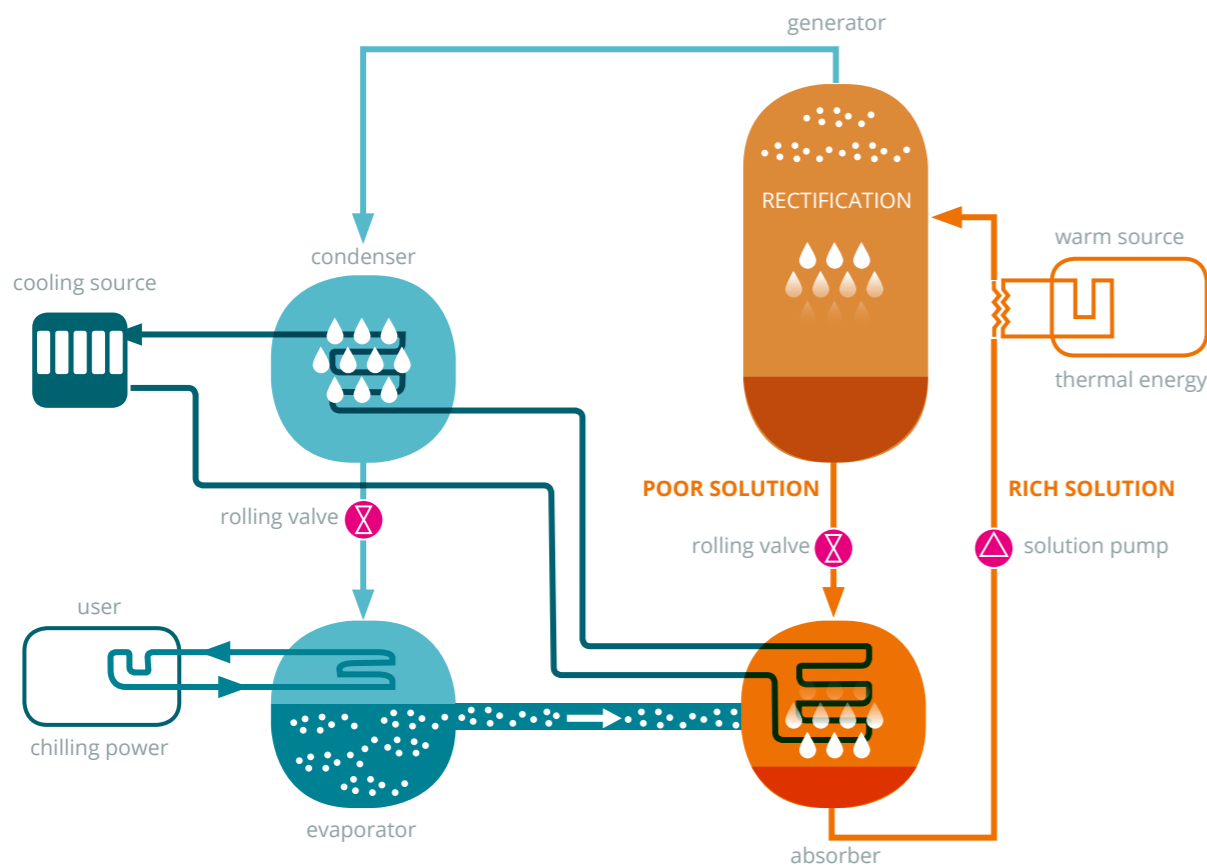

Starting from a **warm thermal energy**, chilling absorption machines produce chilling power. This is different from what occurs with vapor compression machines, using electro-mechanical work to get the same goal. In absorption chillers, the compression process is replaced by the solutions pump. In the absorber, ammonia, in the gaseous form, coming from the evaporator, is absorbed in the water/ammonia solution. This solution, become "rich", is pumped into the generator (high pressure circuit), where the warm thermal energy source transfers heat to it. Ammonia is again separated by the solution to be chilled and liquefied in the condenser. Liquid ammonia is then expanded and sent to the evaporator, creating cold. The "poor" solution is sent back to the absorber. Condenser and absorber heat is dispelled from the evaporative tower and/or the evaporative condenser.

Energy diagrams

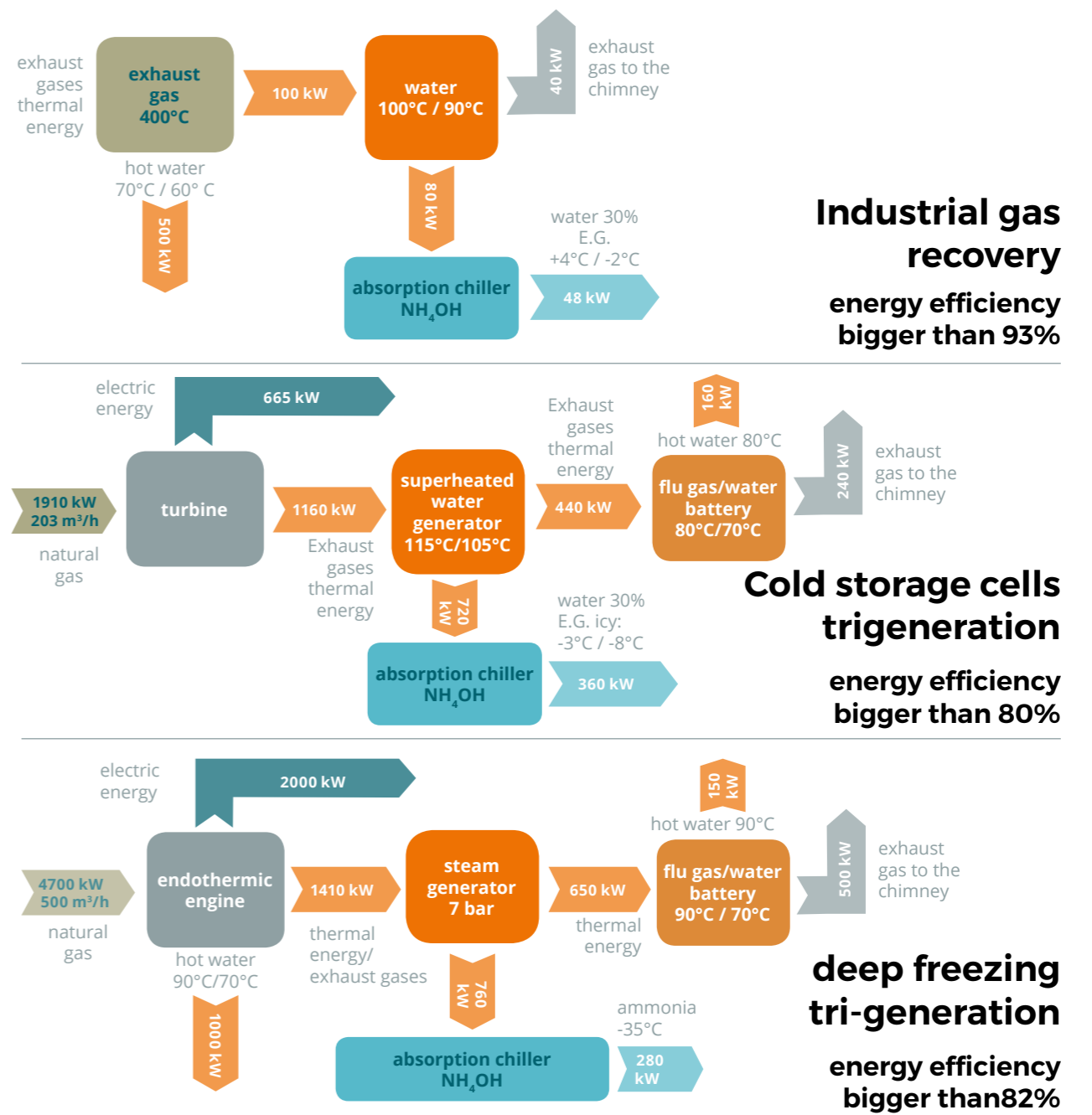



Technical data

enermatik® HT high temperature

water	+5°C / 0°C H ₂ O
warm water	+95°C / +85°C
COP	0,58

enermatik® MT medium temperature

glycol	-5°C / -10°C
over-heated water	+110°C / +100°C
COP	0,5

enermatik® MLT medium low temperature

glycol	-20°C / -25°C
over-heated water	+140°C / +130°C
COP	0,42

enermatik® LT low temperature

ammonia	-35°C
over-heated water	+170°C / +160°C
COP	0,38

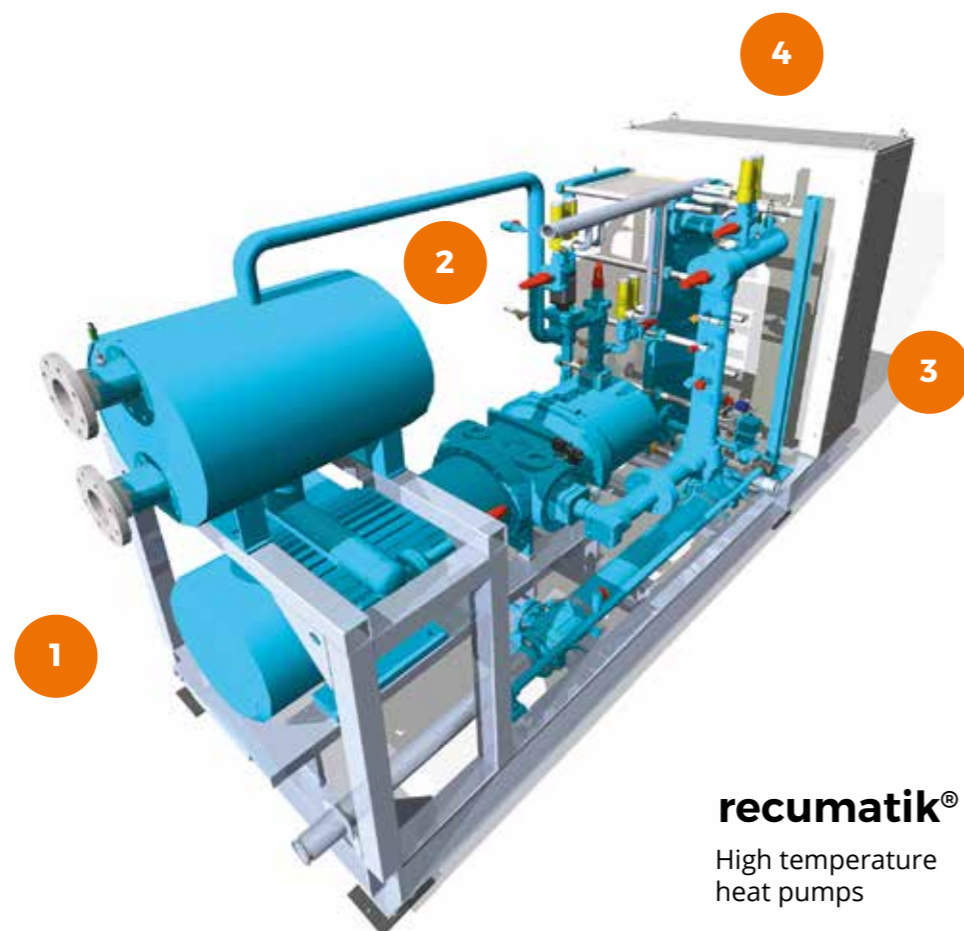

recumatik®
High temperature
heat pumps

New hospital of Leoben, Austria

They did not want to install coal boilers anymore neither they wanted to think of electric heat pumps.

They were looking for a supplier, on the market, who could offer high energetic efficiency, ecologically compatible, very reliable, long lasting and easy to support machines. They also discovered that the most efficient heat pumps were those using ammonia as refrigerant.

But they needed to find who were able to design these complex systems, to install them taking care also of start up on the site.

We offered and supplied all that, together with a remote control and maintenance system. We gave them **recumatik®**

1 Geothermal

Heat pumps are born to use the subsoil heat as a source of constant temperature inexhaustible energy.

2 Combined working

The chiller works as a boiler and a chiller at the same time. According to external temperature conditions and to the customer priorities, the control system adjusts the heat and cool production.

3 Footprint size

Heat pumps are usually installed in the basements. We designed a compact chiller that can be easily sectioned and transported, even in elevators and through small size doors.

4 Power saving

Being a **green-chiller** means to reduce operating costs vs. fossil fuels and to reduce CO₂ emissions

Product line

recumatik®

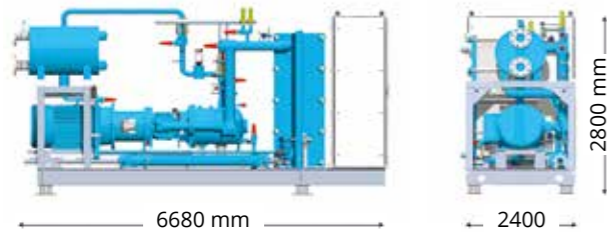

recumatik® HP



screw recumatik®

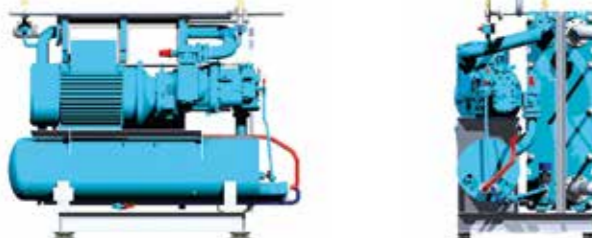

recumatik® + windmatik®



Characteristics:

- temperature up to 90°C
- very silent
- fossil fuels use elimination
- easy to install and transport
- water heating at three temperature levels
- PED 97/23/CE certification and test according to ISO 9001:2008

Options and accessories:

- engines and inverter available with efficiency IE4
- available with piston or screw compressors
- available with sectioned modules
- versions of very high efficiency with subcooler and desuperheater
- new soundproof cabin with integrated safety devices for ammonia
- supervision and telemetry system for on-line management **telematik®**
- versions with ammonia charge less than 15kg
- available in air recovery/condensed version using **windmatik®**
- recovery on: condenser, desuperheater, compressor, electric engine and subcooler
- ATEX versions

Heat pumps

recumatik®



We have more than 20 recumatik® working since 1994

Technical data

Chiller mode

water temp.	+12°C / +6°C	+26°C / +32°C	-	+40°C / +50°C	-	-	-	-
data	Chilling power	Condensation power	Subcooler	Desub-heater power	Absorbed electric power	EER (cool)	COP (heat)	COP TOT
recu 4	636,8 kW	737,8 kW	0	64,1 kW	110,6 kW	5,76	6,81	12,57
recu 6	955,2 kW	1105,3 kW	0	96,1 kW	163,9 kW	5,83	6,88	12,71
recu 8	1273,6 kW	1472,8 kW	0	128,2 kW	217,2 kW	5,86	6,91	12,78

Heat pump mode

water temp.	+12°C / +6°C	+40°C / +50°C	+25°C / +35°C	+60°C / +70°C	-	-	-	-
data	Chilling power	Condensation power	Subcooler	Desub-heater power	Absorbed electric power	EER (cool)	COP (heat)	COP TOT
recu 4	596,5 kW	678,1 kW	53,3 kW	101,2 kW	154,8 kW	3,85	4,90	8,76
recu 6	894,8 kW	1016,2 kW	80 kW	162,7 kW	230,2 kW	3,89	4,94	8,82
recu 8	1.193 kW	1.354,4 kW	106,6 kW	234,2 kW	305,7 kW	3,90	4,95	8,86

Icy water chillers

Our alternative to ice accumulation tubs



zeromatik®

is a patented system that, when installed on any our chiller, can cool water at a constant temperature of 0,5°



Orogel and Galbani use to produce and work on large amounts of food:
Orogel, on vegetables, Galbani on milk and dairy products.

Both these companies use large amounts of icy water to cool products during their processing.

In the past, vegetables and milk were cooled making huge water amounts to flow through huge ice accumulation tubs.

But this system didn't allow to keep constant temperatures all day long.

Both companies needed to keep a temperature of about 0 degrees and, if possible, to reduce the clutter of big ice accumulation tubs.

We proposed them a plate heat exchanger, ammonia chilled. This machine uses less energy and ensures a constant temperature.

Zudek machines, of small size, were directly introduced into their chiller systems, with the great advantage of avoiding to create new installations.

Today these machines are still working at full rate, the two customers are satisfied and their word of mouth allowed us to get new customers.

Accessories and components

Compression and separation modules

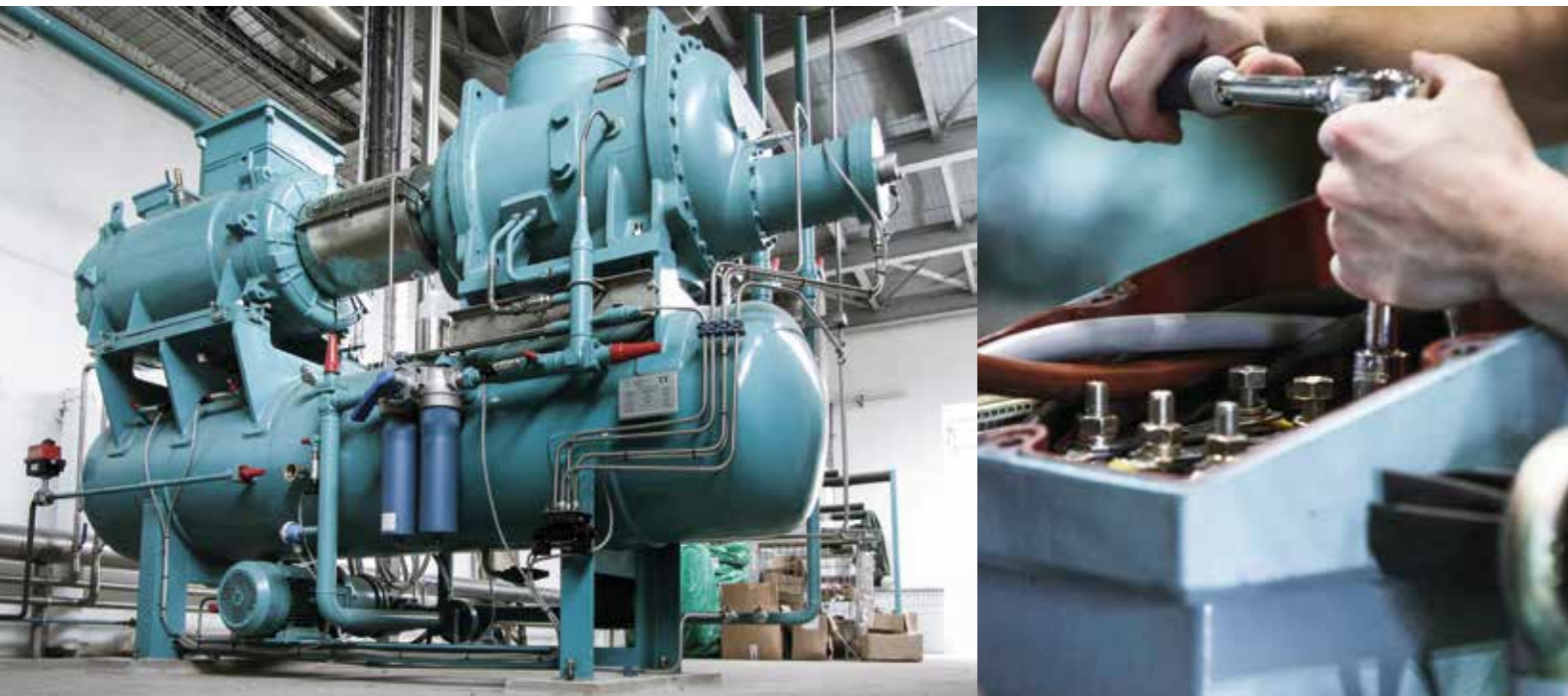

Our compression lines were built after a deep analysis of induced vibrations and resonances, that are the main causes of any mechanical component failure.

We came to this point after years of experience on chilling systems in naval area, at the beginning of our activity.

Our compression lines are therefore the best you can find today in the market.

Accessories

- power electric panel
- starter/inverter
- economizer
- condensation system adjustment
- anti-vibration
- additional safety systems
- acoustic panelling
- multiple centrelines control system
- telemetry for on-line management **telematik**®

Electric panels

Power and control electric panels

To be sure of the actual control systems reliability, we use to make, in our workshops, all electric panels and installations. We use to test them at full load with Power Test, before letting them go out from the workshop itself.

Touch-screen of last generation

Electric panels are supplied with touch-screen to facilitate your control and programming operations. The graphic interface is adapted to every project in order to provide an intuitive and easy-to-manage control.

We create dedicated software that we use to customize according to the installation country and to the specific requests.



Accessories and components

scrubber

pressure equipment

Ammonia vapours abatement systems

The scrubber is a tool allowing to reduce the substances concentration in a gas stream. These tools find a wide application in ammonia chilling systems to increase the safety level.

We design and manufacture abatement scrubbers to be coupled to any chillers or installations, even already existent.

If a chiller of ours, with outdoor cabin, is supplied together with the scrubber, metal structures are designed and manufactured to support the load on the roof.

We certify all scrubbers and metal structures of our production.

The installation size is developed in height, so reducing the encumbrance. We integrate the ammonia detection system and the scrubber working logic in the chiller management system.

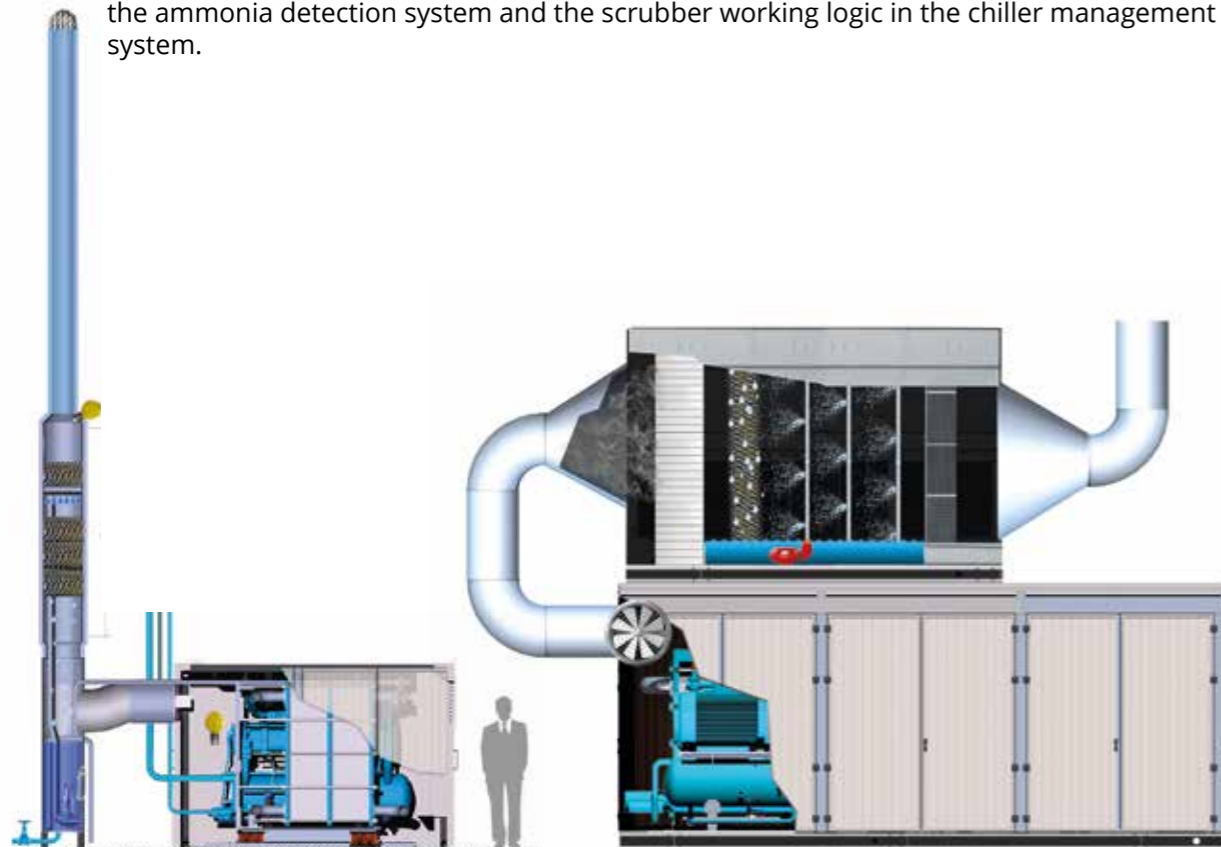

Vertical scrubber on **recumatik**® indoor cabin

Horizontal scrubber on **varimatik**® outdoor cabin

Certification

Each pressure vessel is designed according to the destination country:

- Europe applies the PED 97/23/CE acted by the European Community, which governs design, manufacturing, equipment and safety installation of pressure tools
- in a similar way, USA apply the ASME code

Oil separators

To ensure our ammonia chillers maximum efficiency we use to separate oil from the refrigerant flow during the four separation stages:

- centrifugal stage
- inertial stage
- stage with demister
- stage with coalescing filter

Therefore, we get an unmatched separation efficiency.

Heat exchangers

In many applications it was necessary to have heat exchangers specially built, we started to make them in our workshop. Today, thanks to our accumulated experience, we are able to produce:

- shell and tube heat exchangers and boilers on drawing
- liquid/liquid, gas/gas, gas/liquid exchangers
- condensers
- evaporators
- oil coolers
- subcoolers, desubcoolers and desubheaters
- economizers

Accessories and components

Pressure equipment

Liquid separator

Our phase separators are designed to eliminate liquid drops drag to compressors, containing, as much as possible, the vessel size and the refrigerant charge. We can design and build horizontal or vertical separators that can be pre-mounted on the frame with the following accessories:

- flooded evaporator
- economizer
- refrigerant pumps unit
- valves, control and security tools

Rectification columns for absorbers

To get maximum returns on our absorption machines, we optimized the theoretical model to calculate rectification columns. We then built one, two, or three separation stages columns, specifically made for our absorbers.

Pumping stations

Stations integrated with chillers

To satisfy and simplify our customers' needs, we equip our chillers with pumping stations. They can be either mounted or they can be on-board, integrating the systems either with a single Monobloc, ready for use, or installed near the chiller.

The pumps unit, on demand, can be equipped with any measurement, regulation and control tools. It can be managed by the machine PLC.



Accessories and components

Covers, carpentry and insulations

Outdoor chillers are our specialty

Our ergonomic vision of installations led us to suggest many customers of ours to install outdoor chillers, in order to optimize production spaces and to simplify safety management.

We were the first ones to make chillers with self-supporting metal structure, that didn't need foundations and footing to be made on-the-site.

Since ever our chillers are easy to transport, to install and to start-up.

We produce covers to solve big thermal fluctuations, salt aggression, atmosphere corrosion, acoustic insulation problems.

Therefore, we know how to design and build structures and covers in many materials, for many specific needs.

Structures are designed according to Eurocodici and are made with EN1090 certification.

Insulations

Thermo-acoustically isolating a chiller requires specific skills.

We design and make thermos-acoustic insulations for every chiller element or for the whole cabin.

In the preliminary stage, we suggest the best materials to satisfy our customer's needs.



Services

Sharing Knowledge Helps to Generate Better Solutions



Always on Your Side

More than 30 years of experience on the field allow us to give you:

- Direct support with Zudek technicians
- remote support with our **telematik**® systems
- reduced intervention rates
- interventions on any kind of plants and machines
- vehicles and drivers authorized to transport in ADR (ammonia, oils, refrigerants...)
- availability and telemetry service 24h/24.
- service department with 'Problem solving' outstanding qualities
- training and updating programs for refrigeration and maintenance technicians
- training programs to get toxic gases licenses
- technicians with F-GAS and toxic gases licenses
- PED qualified welders

Technical specialists to cope with:

- cooling technique with ammonia
- mechanical/vibrations/noise
- electrical engineering and drives
- PLC/PC/SCADA software
- welding
- safety with ammonia
- PED qualified welders



**We Transform
Your Dreams into
Solutions**

360° consultancies to identify the best solutions

- we make feasibility studies
- we design preliminary studies
- we make operating projects
- we take charge for you of the ministerial practices
- we select the best components
- we design pressure components (heat exchangers, containers and other)
- we design electrical, automation, control and safety installations
- we design maintenance plans and worksite safety
- we design according to standards (PED, ASME, ATEX, RINA)
- we design all the required software to manage and support your installation

We use technologies for three-dimensional design, so that we can show you a virtually made installation. We can optimize our manufacturing process and the final product quality.

We actively take part to worldwide projects and university events.

We give you the design process total quality.

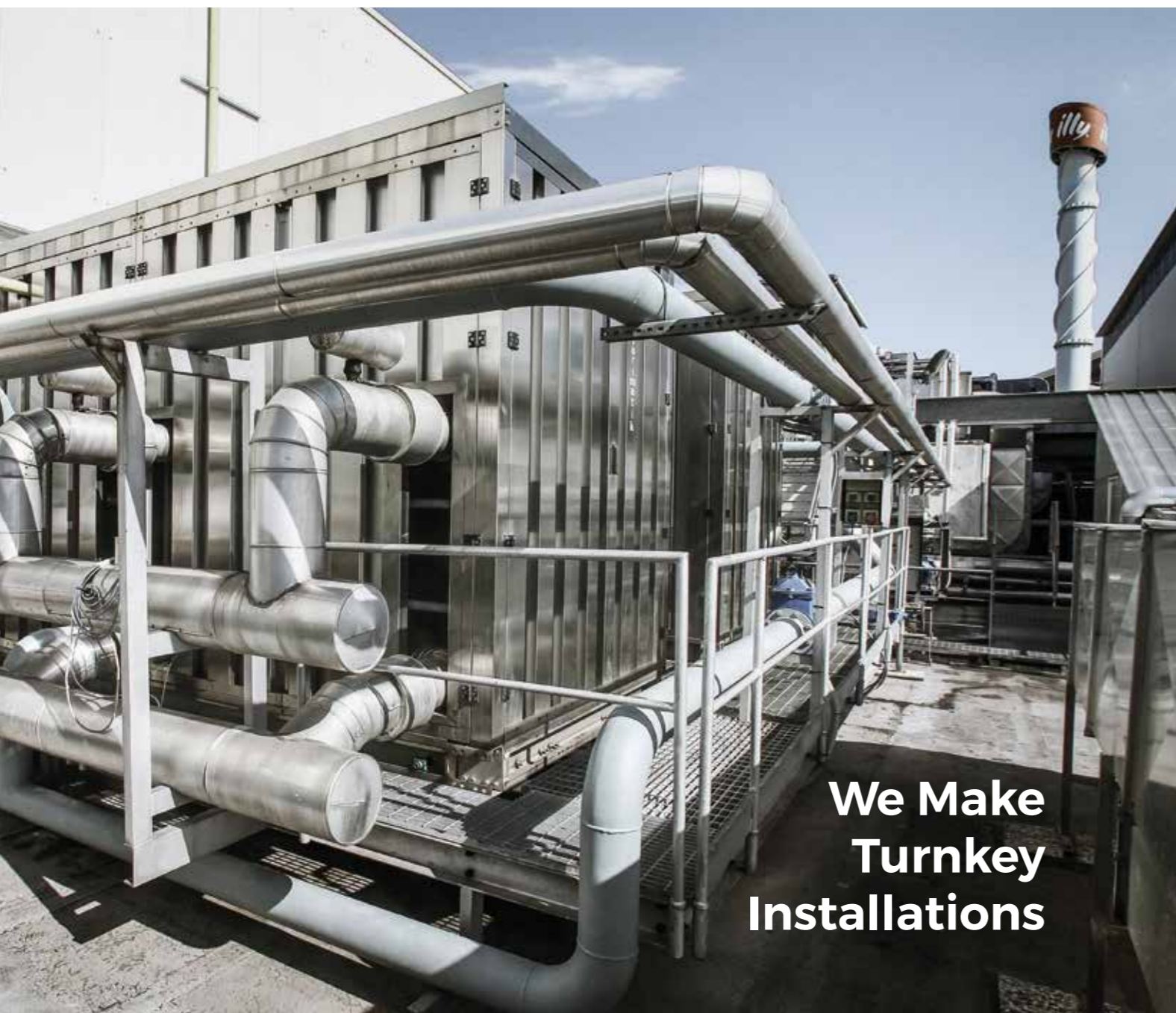

**We Make
Turnkey
Installations**

Our multidisciplinary approach:

- we supply components
- we make refrigeration installations
- we make electrical installations
- we make metal structures
- we install plants and safety systems
- we share with you mounting, testing and maintenance plans
- we use to weld according to ASME & EN standards
- we organize construction sites

We work under total quality control.

Our proposals come out after we have understood our customer's actual needs.

We use to evaluate the best solution with active cooperation.

With Zudek solutions you can achieve the goals you want



**Power test:
a Warranty for
our Customer**

Every Zudek machine is tested and tried at full load in the factory before shipment:

- we test every chiller in every part, optimizing working parameters in the required conditions
- we reduce calibration and commissioning timing on the site
- the factory test is a warranty for our customer: we use certified tools and give test protocols with recorded data
- hydraulic pressure test and x-rays exams control are made according to Zudek quality procedure, that is supervised and certified by ISO 9001 qualified institutions:2008 PED 97/23/CE
- we schedule maintenance and dedicated machines/installations management with more specialization levels

We keep every promise

A person wearing a dark grey long-sleeved shirt is holding a white smartphone. The phone screen displays a complex data dashboard with various charts, graphs, and text. The background is a blurred industrial workshop with various tools and equipment.

Communicating with You 24 Hours per Day

telematik®:

Every machine, every installation can be supervised and monitored through telemetry; thanks to this service, technicians can control, in real time, all parameters, ensuring remote assistance.

This interface system has been developed for your own needs. Every information, which was previously recorded by our control telemetric system, contributes to increase our knowledge of the environment where the machine was installed. Therefore, we can continuously improve in terms of functionality and efficiency.

We can offer three service levels:

teleSUPPORT

We connect online with your machine and give you a phone advice for its performing analysis.

teleINSPECTION

We perform an online analysis and control of the machine work.

telePRESENCE

On the basis of historical data, we can perform the required controls and we can optimize the machine work, adapting it to the specific environment where it is installed.

telematik® service can be used also for other installations.

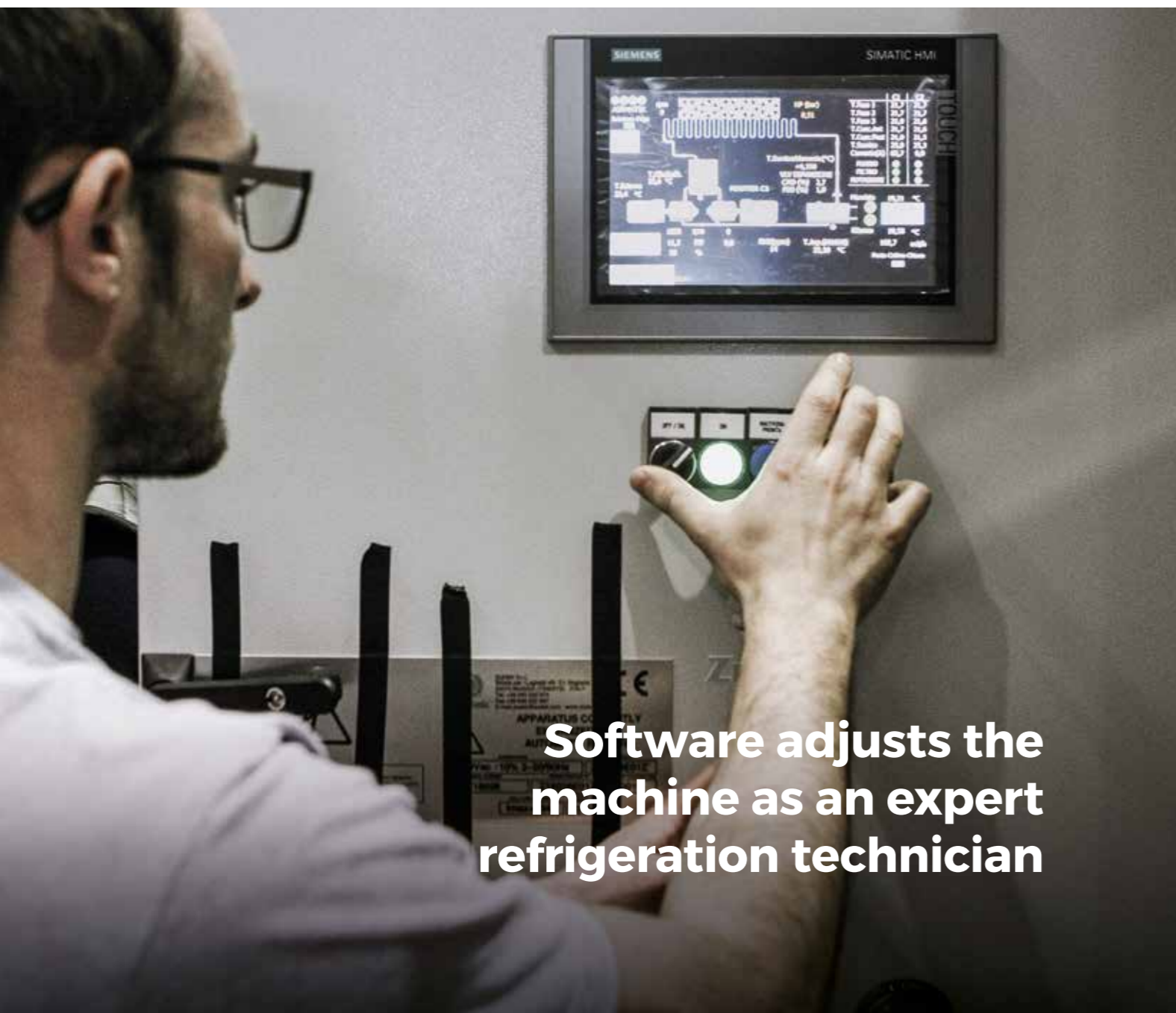

Software adjusts the machine as an expert refrigeration technician

Our management software:

- activates engines and valves in order to **get the maximum COP**
- continuously controls **condensers** and **evaporators** cleaning and reports maintenance needs.
- controls the correct **refrigerant charge** and warns in case of poor charge
- monitors the **perfect lubrication** and detects which filters are dirty and identifies other problems
- **detects any refrigerant leaks** and acts on warning and safety systems
- controls **magnetic and thermal protections** status of all chiller electrical components and eventually asks for a guided intervention
- automatically adjusts the **set point** during the day, for instance when a daytime chilled water production and an overnight ice accumulation are needed
- continuously monitors **electrical power quality**
- when needed, can cut down the **electrical power input**, for example, in specific time frames
- **asks for support** every time the processed values are far from normality
- warns in **case of vibrations** on the chiller to prevent possible damages
- detects electro technical values for every single motor and action

**Skills and crafts
handed down from
generations**

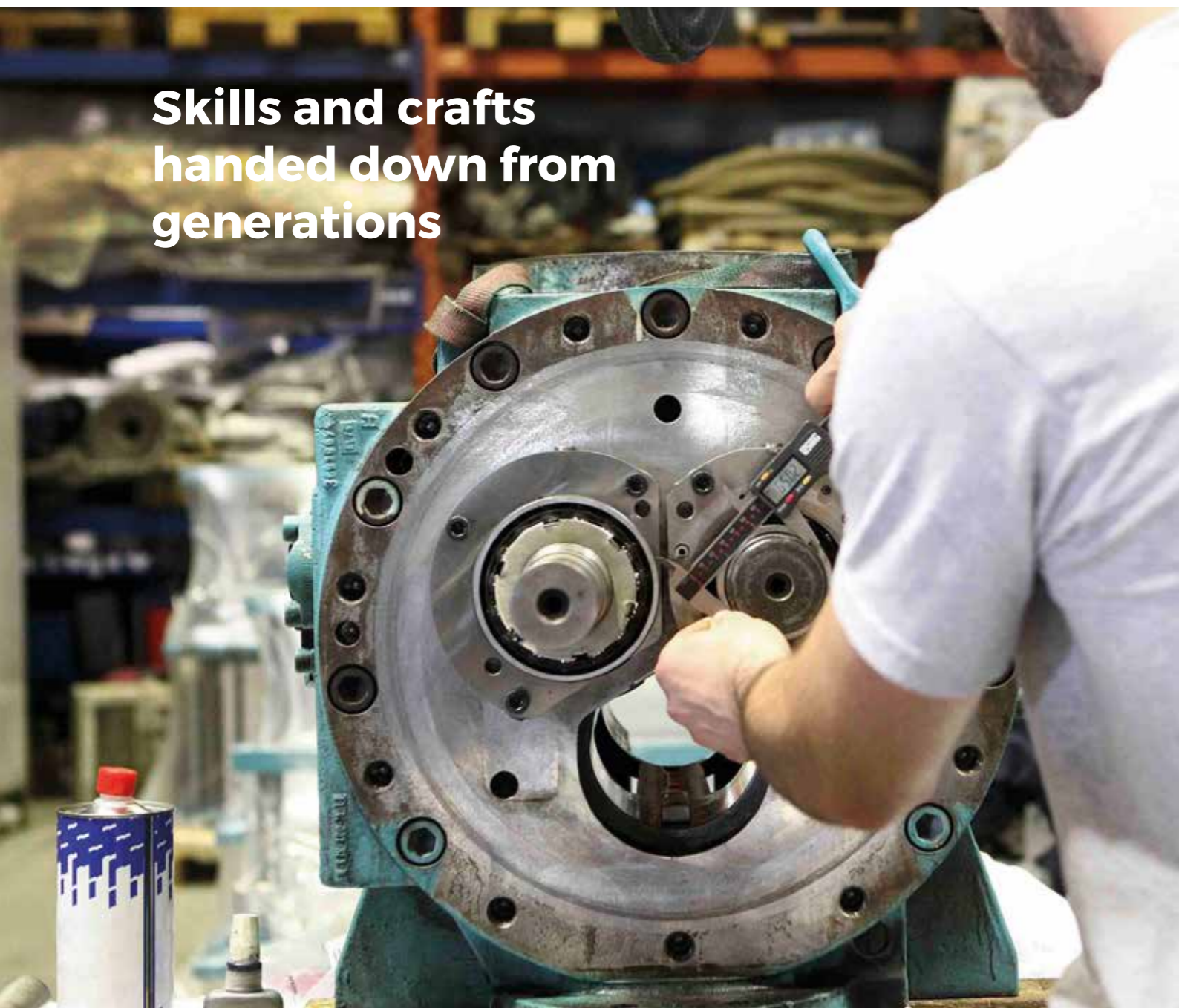

Installations and chillers review and requalification

Our technical and professional experience enables us to offer a review system. This service consists in existing components analysis, in drawing up a renovation plan and in upgrading either in our workshop or on the site.

We make reviews, updates and requalifications of:

- chilling systems
- chillers
- electric installations
- Ammonia safety installations
- Compressors
- Electric engines
- Heat exchangers
- Separators
- Pressure vessels
- Pipes
- Change in electro-mechanical installations with PLC/SCADA programmer's introduction
- PED (D.M. 329/2004 & D.M.11/04/2011) requalification
- Adapting systems
- Steel structures

your notes

When a company decides to follow Zudek philosophy for its plants, tools and maintenance, actually grows.

Usually, this kind of companies grows quickly.

In fact, a customized solution is not just a dream, it is a need.

It provides several benefits that standard solutions are not able to give.

Zudek srl

Strada per i laghetti 9
34015 Muggia (TS)
Italy

Contats:
zudek@zudek.com
Tel. +39 040 232674
Fax +39 040 232687

Technical assistance:
tecnico@zudek.com
Tel. +39 040 232685

Sales department:
sales@zudek.com
Tel. +39 338 6495902

CCIAA-NREA TS-124118
VAT n° IT 00783180326

www.zudek.com